

REV	LTR	DESCRIPTION	DATE	APPROVED
A0			20141006	LTY

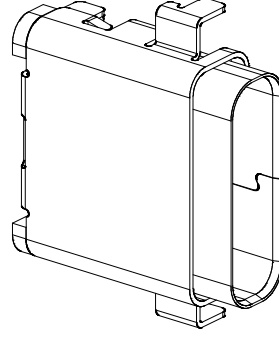
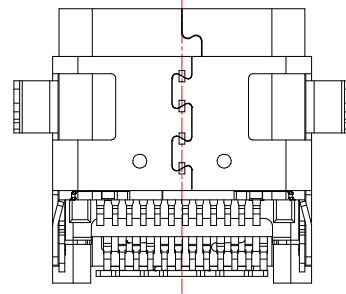
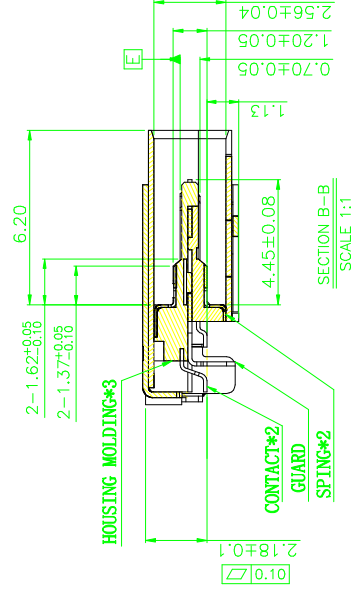
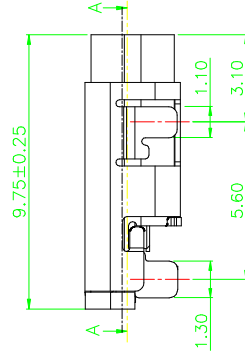
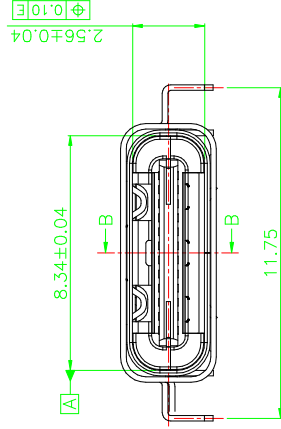
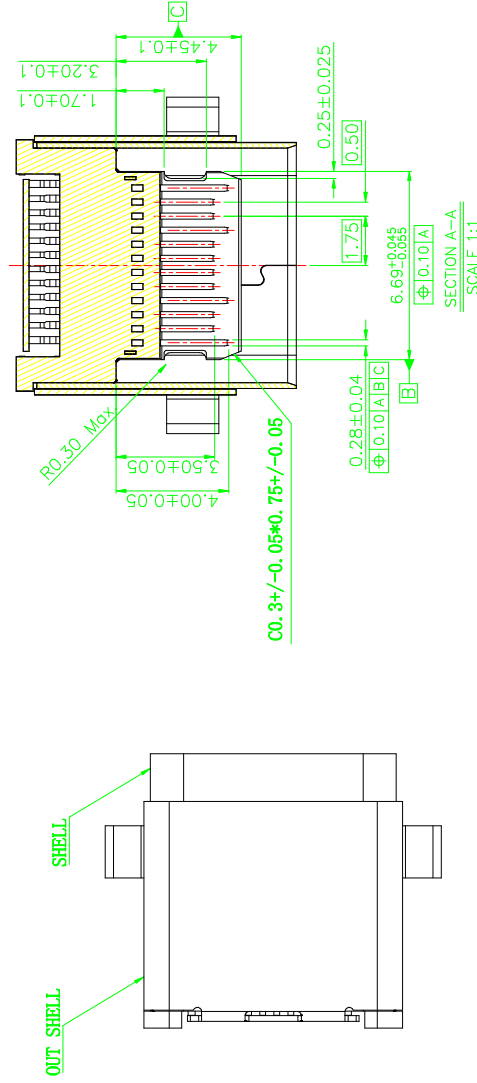

备注:

1. 材质:
 - 1.1 胶芯: LCP+30%G.F UL94V-0 黑胶
 - 1.2 端子: C5210, 镍底, 镀金15U"
 - 1.3 外壳: 不锈钢, 表面镀镍
 - 1.4 卡钩: 不锈钢, 表面镀镍
 - 1.5 弹片: 不锈钢,
2. 主要特性:
 - 2.1 额定电流: 5A
 - 2.2 接触阻抗: 30mΩ MAX
 - 2.3 绝缘阻抗: 100MΩ MIN 250V DC
 - 2.4 耐压测试: 250V AC
 - 2.5 沾锡性: 温度250±5℃, 时间5±0.5s
 - 2.6 整体插入力: 3.57kgf MAX
整体拔出力: 1.02kgf MIN
耐久: 10000次

TOLERANCES	
.X	±0.15
.XX	±0.10
.XXX	±0.05
ANGLES	±2.00°

APPD. :	
CHECK:	
DRAWN:	LTY

TITLE: USB 3.1 Type-C母座沉板双贴片
PART NO.: SHK-31257
DRAWING NO.:

REV. :	SIZE:	UNIT:	SCALE:	SHEET:
A/0	A4	M M	1 : 1	1 / 1

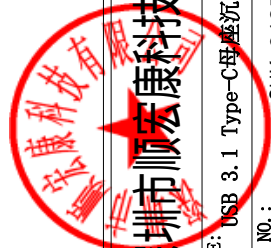

深圳市顺宏康科技有限公司

REV	LTR	DESCRIPTION	DATE	APPROVED
A0			20141006	LTY

USB TYPE-C FULL-FEATURED RECEPTACLE INTERFACE PIN ASSIGNMENTS

PIN	Signal Name	Description	PIN	Signal Name	Description
A1	GND	Ground return	B12	GND	Ground return
A2	SSTXp1	Positive half of first SuperSpeed TX differential pair	B11	SSRXp1	Positive half of first SuperSpeed RX differential pair
A3	SSTXm1	Negative half of first SuperSpeed TX differential pair	B10	SSRXm1	Negative half of first SuperSpeed RX differential pair
A4	Vbus	Bus Power	B9	Vbus	Bus Power
A5	CC1	Configuration Channel	B8	SBU2	Sideband Use (SBU)
A6	Dp1	Positive half of the USB 2.0 differential pair-Position 1	B7	Dn2	Negative half of the USB 2.0 differential pair-Position 2
A7	Dn1	Negative half of the USB 2.0 differential pair-Position 1	B6	Dp2	Positive half of the USB 2.0 differential pair-Position 2
A8	SBU1	Sideband Use (SBU)	B5	CC2	Configuration Channel
A9	Vbus	Bus Power	B4	Vbus	Bus Power
A10	SSRXn2	Negative half of second SuperSpeed RX differential pair	B3	SSTXn2	Negative half of second SuperSpeed TX differential pair
A11	SSRXp2	Positive half of second SuperSpeed RX differential pair	B2	SSTXp2	Positive half of second SuperSpeed TX differential pair
A12	GND	Ground return	B1	GND	Ground return

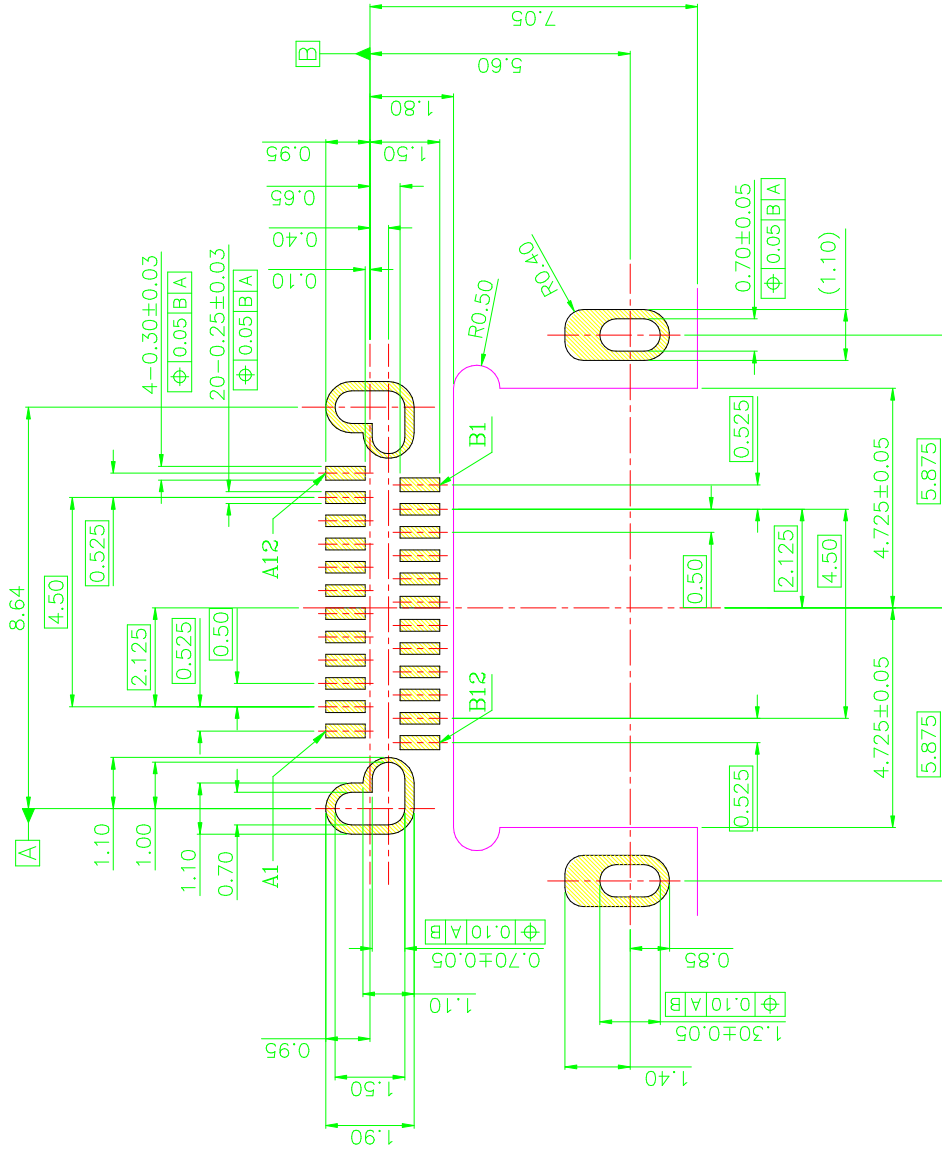

RECOMMEND PCB LAYOUT
(THICKNESS: 1.00 OR 1.20mm)

深圳市顺宏康科技有限公司
 TITLE: USB 3.1 Type-C母座沉板双贴片PCB图
 PART NO.: SHK-31257
 DRAWING NO.:
 APPD.:
 CHECK:
 DRAWN: LTY
 REV.: A/0
 SIZE: A4
 UNIT: M M
 SCALE: 1 : 1
 SHEET: 1 / 1