

REV.	ECN NO OR DESCRIPTION	REVISED	DATE
	PROPOSE ONLY	SIMON	2015.04.09

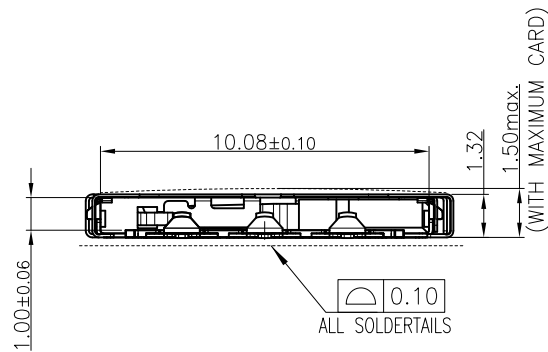
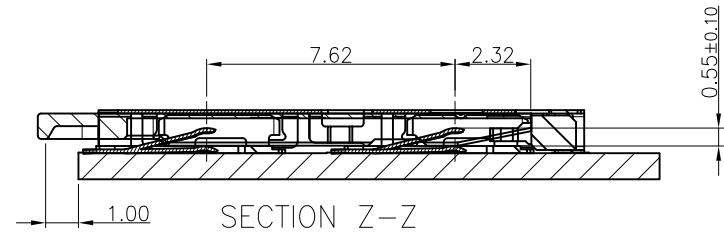
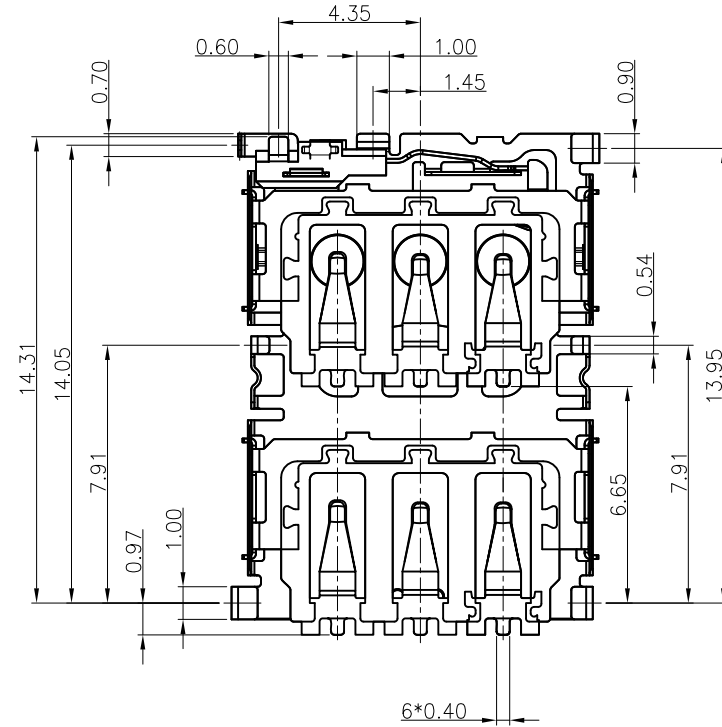
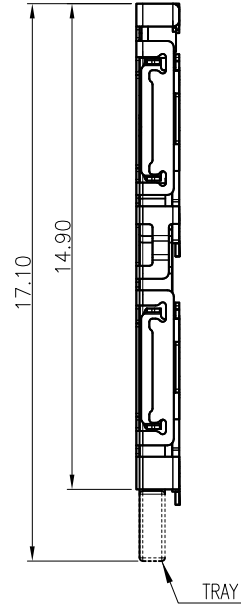
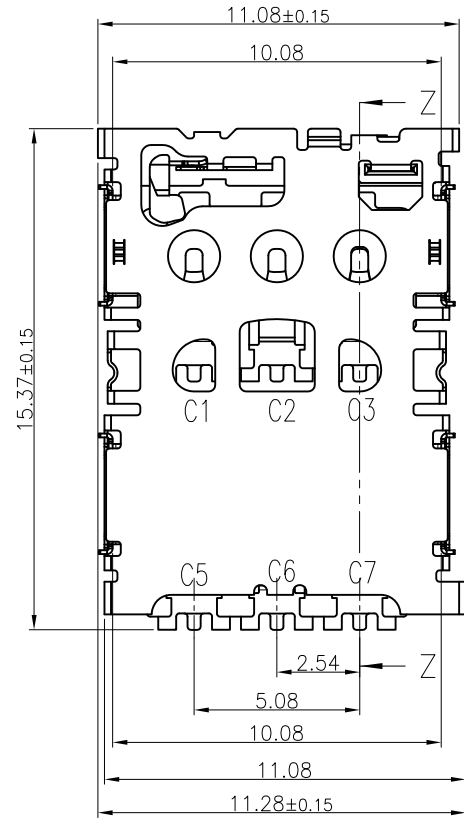

NOTES:

- MATERIAL:
HOUSING--LCP GLASS FILLED, UL 94V-0, BLACK
TERMINAL--COPPER ALLOY
SHELL--STAINLESS STEEL
- PLATING:
TERMINAL-- GOLD PLATING ON CONTACT AREA
GOLD FLASH PLATED ON SOLDER TAIL AREA
NICKEL UNDER PLATED OVER ALL
SHELL--GOLD FLASH PLATED ON SOLDER TAIL AREA
NICKEL UNDER PLATED OVER ALL

3	I/M HSG	1	LCP	BLACK COLOR UL94V-0
2	CONTACT	6	C5210	CONTACT AREA: Au 1~3U* ; SWITCH AREA: Au 1~3U* Min. 1u* Min. gold on lower surface of solder-tail.
1	SHELL	1	STAINLESS STEEL	SOLDER AREA: 1~3u* Min. gold on lower surface of solder-tail.
ITEM	PART NAME	Q'TY	MATERIAL	FINISHING & REMARK
UNLESS OTHERWISE SPECIFIED TOLERANCES				
DECIMALS:		ANGLES:		
X	:±0.5	X	:±2°	
X.X	:±0.20	X.X	:±1°	
X.XX	:±0.10			
TITLE				Nano SIM Card(WITH TRAY) 6pin 1.32H CONN.
DWN	JOHNLE	PART NO. NSONL-130006-32GN		
CHKD	KEVIN.D	SCALE:1:1	UNIT: mm	
APVD	SIMON.M	SIZE: A4	SHEET:10F 1	REV: A
CUSTOMER COPY				

REV.	ECN NO OR DESCRIPTION	REVISED	DATE
	PROPOSE ONLY	SIMON	2015.04.09

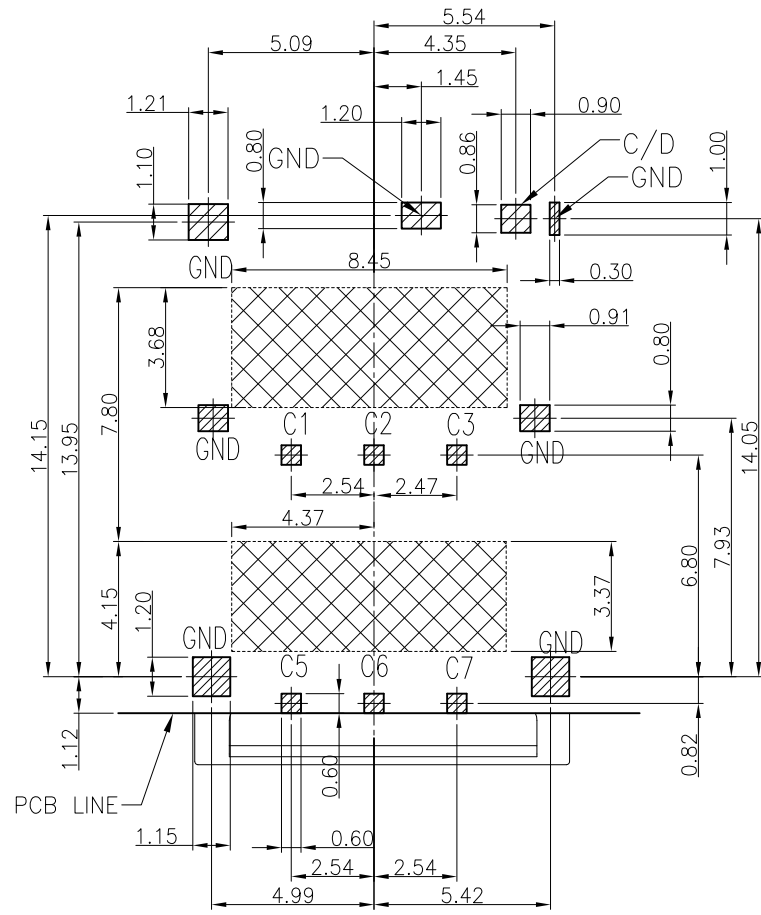

Recommended PCB Layout

(General tolerance:±0.05)

- SOLDER AREA
- THIS AREA CAN'T BE PRINTED CIRCUIT

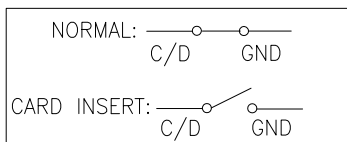

NANO-SIM-PIN	
P/N	NAME
C1	VCC
C2	RST
C3	CLK
N/A	Reserved
C5	GND
C6	VPP
C7	I/O
N/A	Reserved

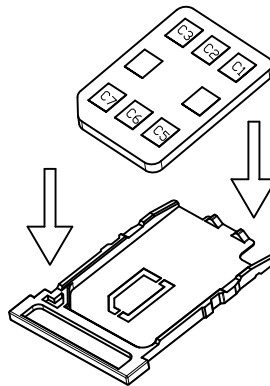

NANO-TRAY

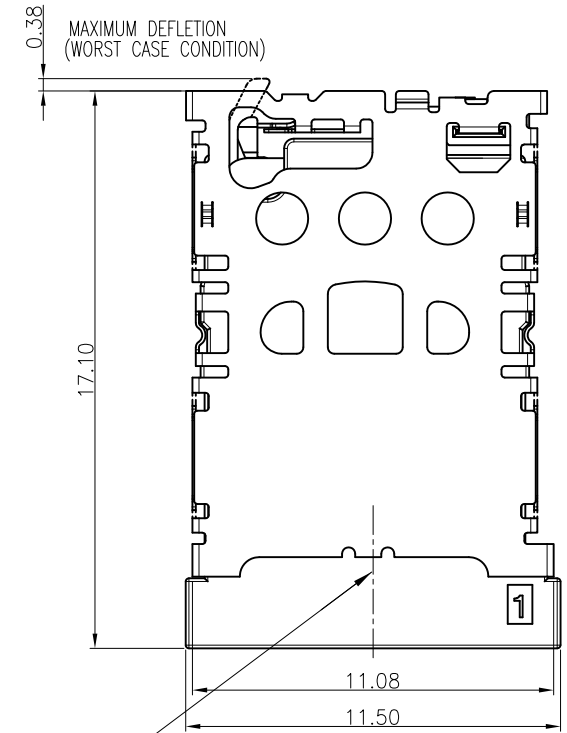
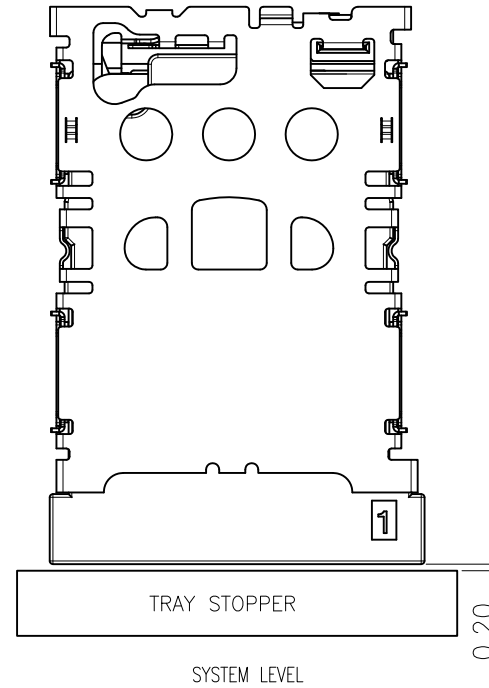

CENTELINES OF TRA AND CONNECTOR OPENING ARE THE SAME CONNECTOR WITH TRAY

UNLESS OTHERWISE SPECIFIED TOLERANCES

DECIMALS:	ANGLES:
X :±0.5	X :±2°
X.X :±0.20	X.X :±1°
X.XX :±0.10	

深圳市顺宏康科技有限公司

TITLE	Nano SIM Card(WITH TRAY) 6pin 1.32H CONN.			
DWN	JOHNLE	PART NO. NSONL-130006-32GN		
CHKD	KEVIN.D	SCALE:1:1	UNIT: mm	
APVD	SIMON.M	SIZE: A4	SHEET:1OF 1	REV: A

CUSTOMER COPY

REV.	ECN NO OR DESCRIPTION	REVISED	DATE
	PROPOSE ONLY	SIMON	2015.04.09

NOTES:

1. MATERIAL: POM GLASS FILLED, UL 94V-0, BLACK
2. UNSPECIFIED CHAMFER TO BE 0.10MM
3. NO PARTING LINE OR OTHER DEFECTS ON HATCHED AREA (PICK UP AREA SPECIFIED IN DRAWING)

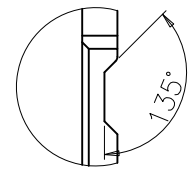
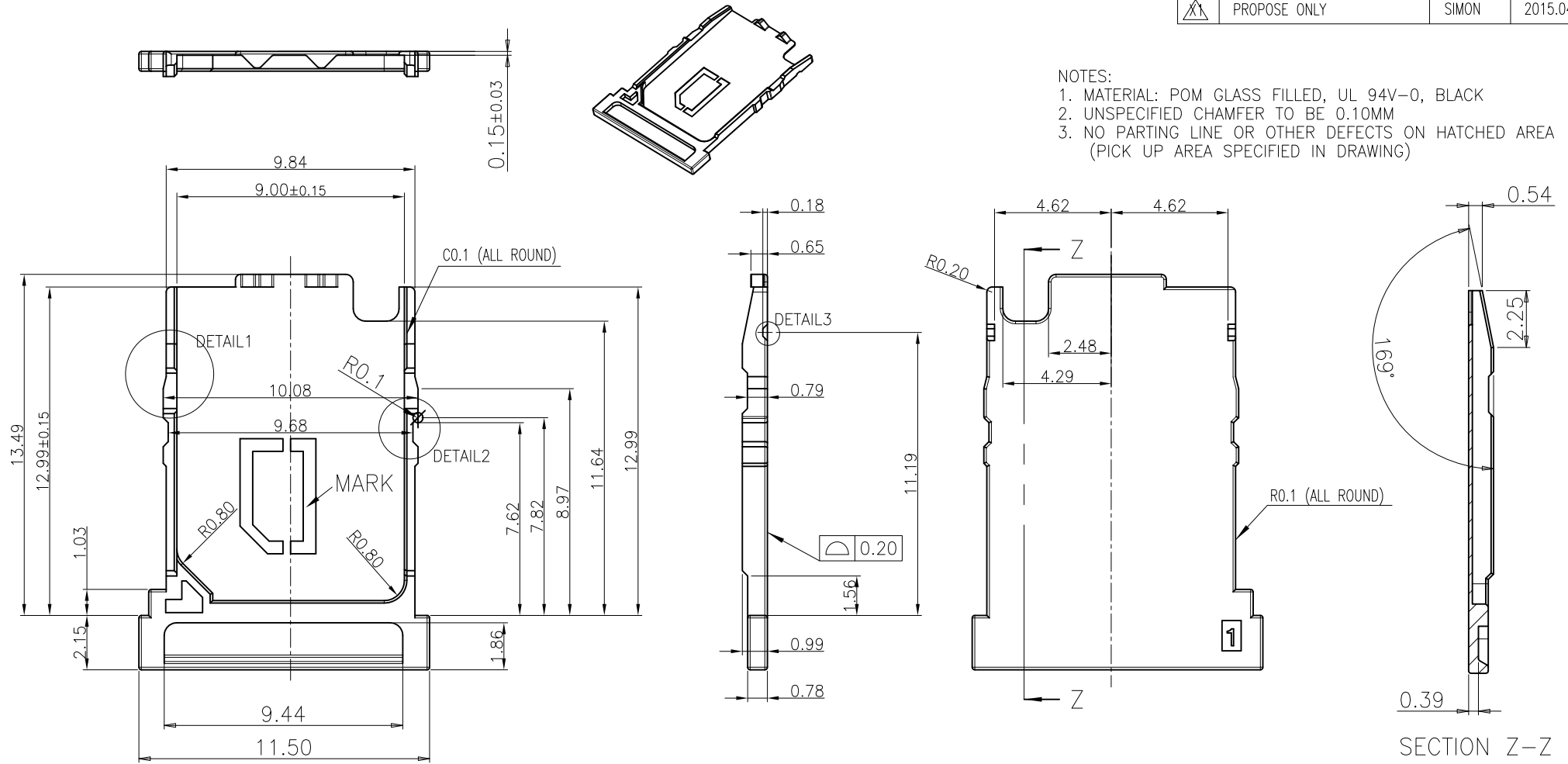

DETAIL2
Scale 10:1

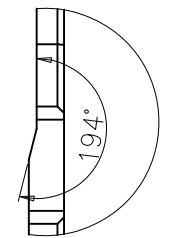

DETAIL1
Scale 10:1

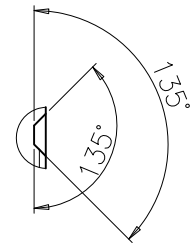

DETAIL3
Scale 10:1

UNLESS OTHERWISE SPECIFIED TOLERANCES					
DECIMALS:	ANGLES:				
X :±0.5	X :±2'	DWN	JOHNLE	PART NO. NSOTR-130006-32GN	
X.X :±0.20	X.X :±1'	CHKD	KEVIN.D	SCALE:1:1	UNIT: mm
X.XX :±0.10		APVD	SIMON.M	SIZE: A4	SHEET:10F 1
		REV: A			
CUSTOMER COPY					