

REV.	ECN NO OR DESCRIPTION	REVISED	DATE
A	PROPOSE ONLY	SIMON	2013.08.22

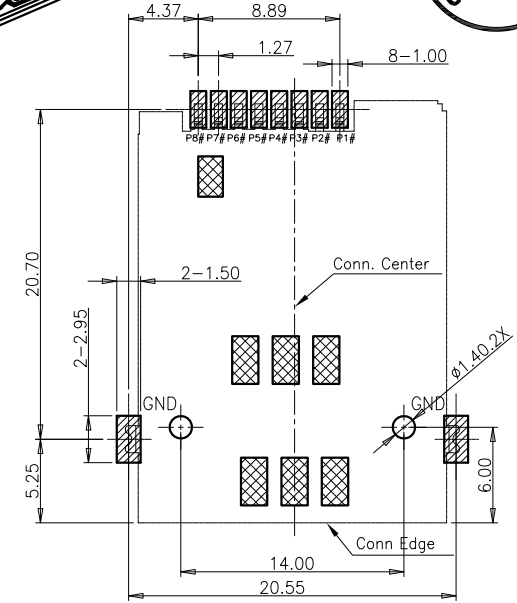
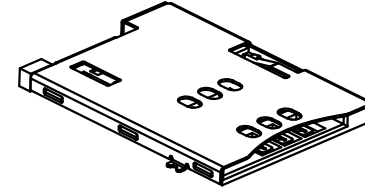
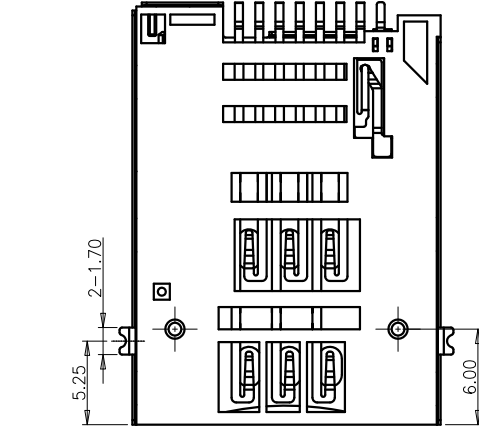
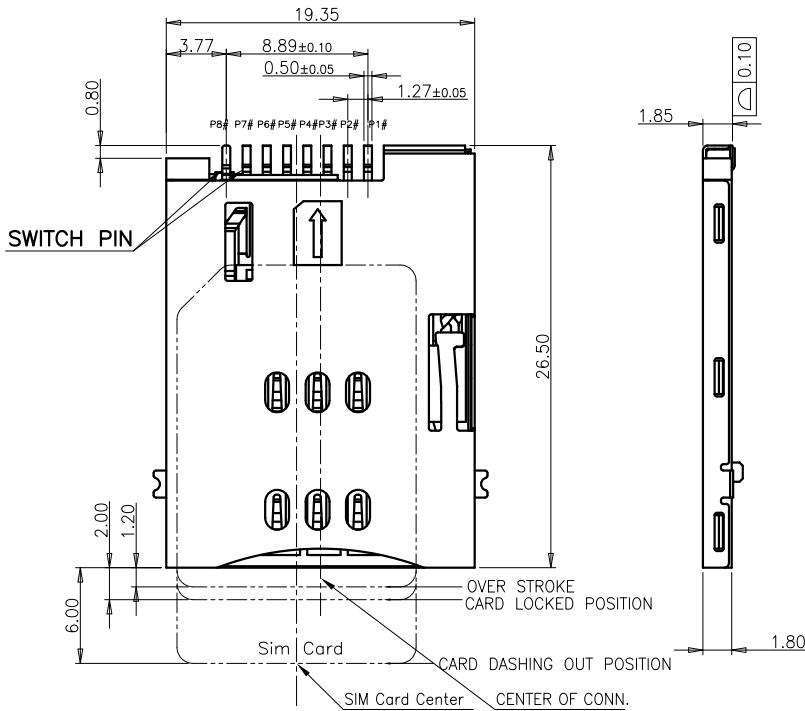

Connctor terminal NO.	Pin NO.
Pin 1	VCC: PWR signal and GND
Pin 2	RST: Reset signal
Pin 3	CLK: Clocking signal
Pin 5	GND: PWR signal and GND
Pin 6	VPP: programming Voltage
Pin 7	I/O: serial data input/output

SOLDER AREA  
 NONE CIRCUIT DIAGRAM AREA

**RECOMMENDED PC BOARD LAYOUT**  
 TOLERANCE:  $\pm 0.05$ [TOP VIEW]

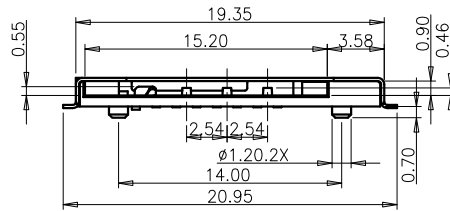

- NOTE:
- ELECTRICAL CHARACTERISTICS
    - CONTACT RESISTANCE: 80 milliohms MAX.
    - INSULATION RESISTANCE: 1,000 Megohms MIN.
    - DIELECTRIC WITHSTANDING VOLTAGE: 500V AC MIN FOR 1 MINUTE.
  - MECHANICAL CHARACTERISTICS
    - NORMAL FORCE: MIN.30gf/PIN MIN
    - DURABILITY: 5,000 CYCLES
    - PRODUCT COPMLIED WITH ROHS
- \*. PART No.:

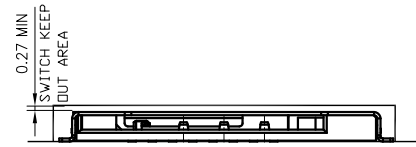

RECOMMENDED SHELL OPENING DEIMENSION

NO.	PART NAME	Q'TY	DESCRIPTION	NOTE
7	COMMON	1	COPPER ALLOY	GOLD PLATING
6	TERMINAL	1	COPPER ALLOY	GOLD PLATING
5	HOUSING	1	THERMAL PLASTIC	
4	SLIDER	1	THERMAL PLASTIC	
3	SPRING	1	SUS	
2	CAM FOLLOWER	1	SUS	
1	SHELL	1	SUS	Ni PLATING

**S 1 PP - 18 00 08- 09 G**  
 SIM SERIES  
 1=WITH POST  
 PUSH PUSH TYPE.  
 18:HEIGHT 1.80mm  
 G=gold flash  
 09=Product Order  
 Pin NO. 08=8Pin  
 00=NORMAL TYPE.

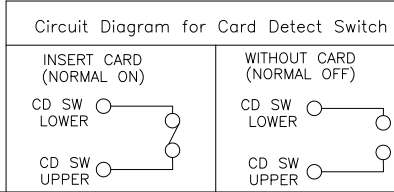

UNLESS OTHERWISE SPECIFIED TOLERANCES

DECIMALS: X :±0.5, X.X :±0.20, X.XX :±0.10

ANGLES: X :±2°, X.X :±1°

TITLE: PUSH SIM Card 6+2pin 1.8H CONN.(WITH POST)

DWN JOHNLE PART NO. S1PP-180008-09G

CHKD KEVIN.D SCALE:1:1 UNIT: mm

APVD SIMON.M SIZE: A4 SHEET:1OF 1 REV: A

CUSTOMER COPY

**深圳市顺宏康科技有限公司**

REV.	ECN NO OR DESCRIPTION	REVISED	DATE
A	PROPOSE ONLY	SIMON	2013.08.22

<图一>

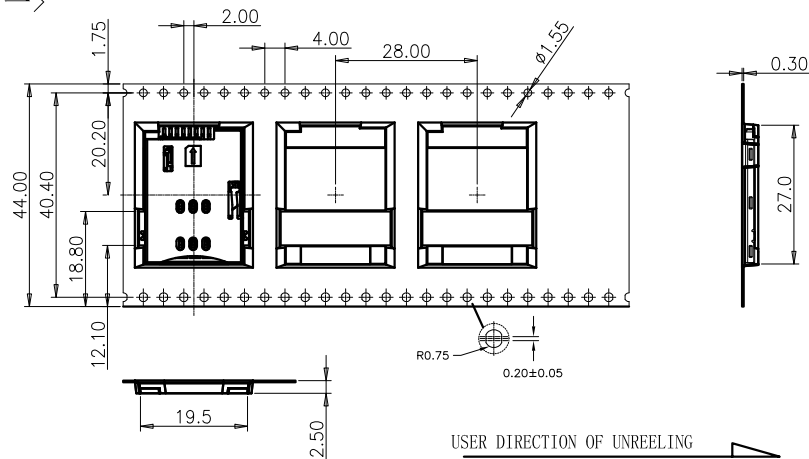

<TABLE 1> PACKAGING QUANTITY

QTY/REEL	REEL/CARTON	QTY/CARTON
550	6	3300

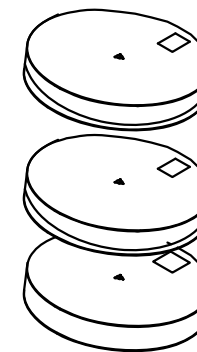

<图三>

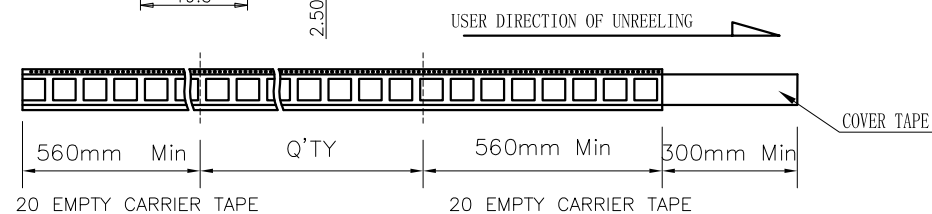
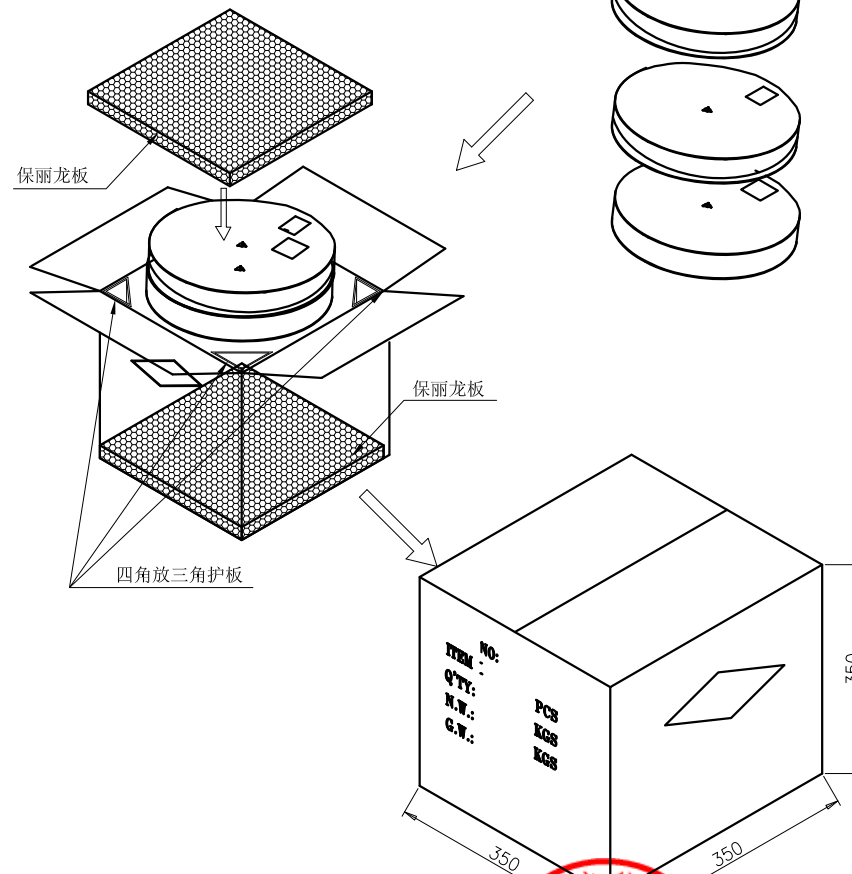

<图二>

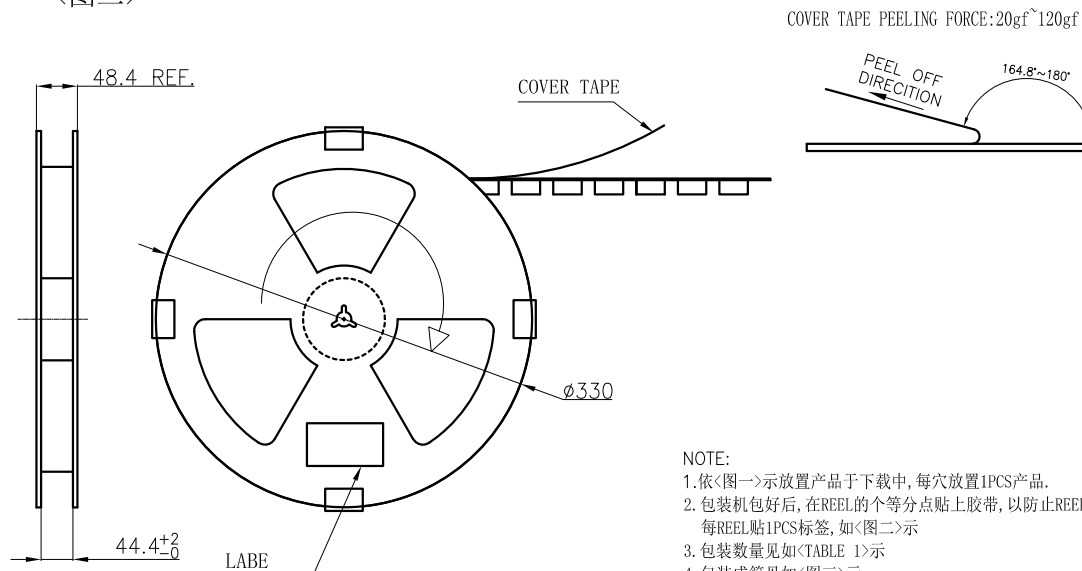

COVER TAPE PEELING FORCE: 20gf~120gf

NOTE:

- 依<图一>示放置产品于下载中, 每穴放置1PCS产品.
- 包装机包好后, 在REEL的个等分点贴上胶带, 以防止REEL张开, 每REEL贴1PCS标签, 如<图二>示
- 包装数量见如<TABLE 1>示
- 包装成箱见如<图三>示  
箱底放保利龙板, 再依次将指定数量的卷装产品放入箱内, 四角分别放入四个三角护板, 最上层再放上保利龙板.
- 封箱, 在封好的纸箱上按客户要求写上料号, 数量等

UNLESS OTHERWISE SPECIFIED TOLERANCES		深圳市顺宏康科技有限公司			
DECIMALS:	ANGLES:	TITLE	PUSH SIM Card 6+2pin 1.8H CONN.(WITH POST)		
X : ±0.5	X : ±2°	DWN	JOHNLE	PART NO. S1PP-180008-09G	
X.X : ±0.20	X.X : ±1°	CHKD	KEVIN.D	SCALE: 1:1	UNIT: mm
X.XX : ±0.10		APVD	SIMON.M	SIZE: A4	SHEET: 1 OF 1
CUSTOMER COPY					