

NOTES:

1. MATERIAL: THERMOPLASTIC SEE PART NO. DESCRIPTION.
HOUSING: COPPER ALLOY.
CONTACT: COPPER ALLOY.
SHIELD: SUS.
2. FINISH:
CONTACT: GOLD PLATING ON CONTACT AREA
50 μ " TIN PLATING ON SOLDER TAIL,
30 μ " NICKEL UNDER PLATING OVER ALL.
SHIELD: 30 μ " NICKEL PLATING.
3. PART NO. DESCRIPTION:
UC X F 0 1 1 6 X - X X - X X - X

- SHELL-PLATED
N: NICKEL
- A: REV.
- O: MARK
- PACKAGE
- O: TRAY
- 2: REEL
- O: HOUSING COLOR
- O: White
- HOUSING MATERIAL
G: PA46 UL94 V-0

- CONTACT PLATED
- C: 30 μ " Au WITH MATTE-TIN
- S: 30 μ " Au WITH BRIGHT-TIN
- A: G/F Au WITH MATTE-TIN
- 1: G/F Au WITH BRIGHT-TIN

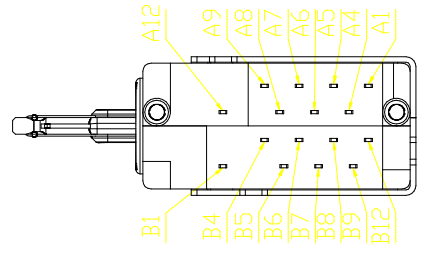
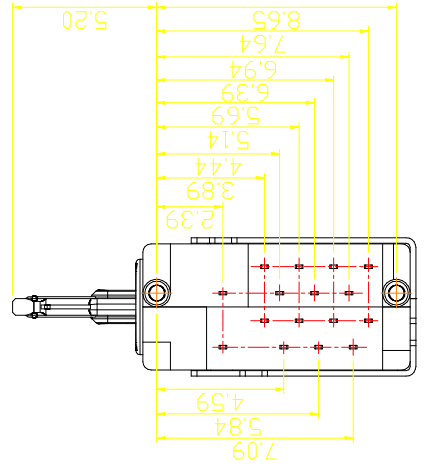
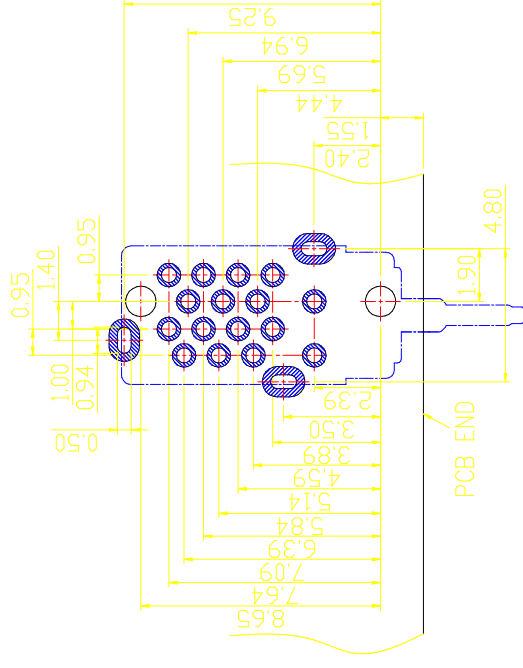
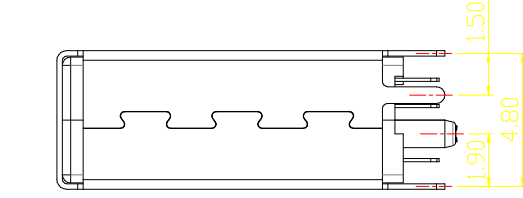
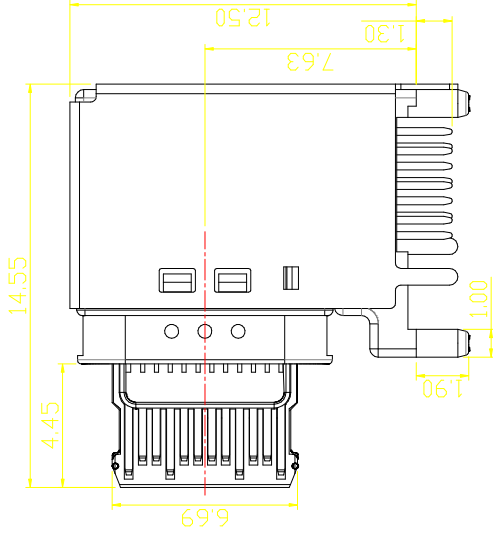
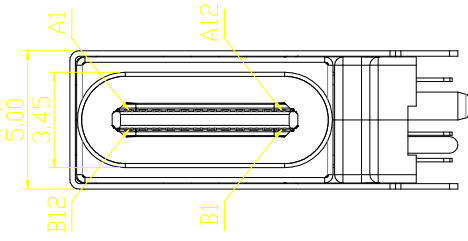
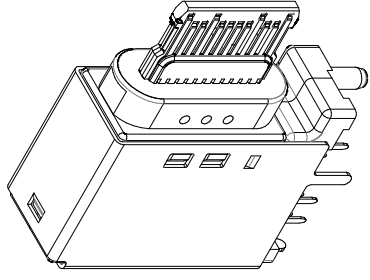
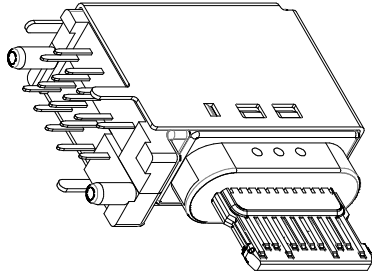
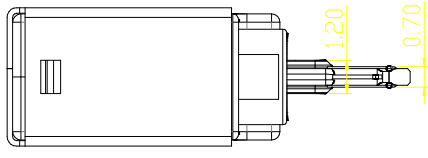

RECOMMEND P.C.B LAYOUT (THICKNESS=1.0mm)
(COMPONENT SIDE) TOLERANCE±0.02

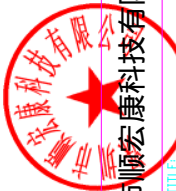

REVISED		REVISED		REVISED		REVISED	
DATE	BY	DATE	BY	DATE	BY	DATE	BY
2015/05/01	A	2016/06/07	Lin	2016/06/07	Lin	2016/06/07	Lin
NEW RELEASE		NEW RELEASE		NEW RELEASE		NEW RELEASE	
APP: Wu Gang		APP: Wu Gang		APP: Wu Gang		APP: Wu Gang	
DRAWN: Wilson		DRAWN: Wilson		DRAWN: Wilson		DRAWN: Wilson	
CHKD: Chen Lin		CHKD: Chen Lin		CHKD: Chen Lin		CHKD: Chen Lin	
APP: Wu Gang		APP: Wu Gang		APP: Wu Gang		APP: Wu Gang	
TOLERANCES: X: ±0.35 X.X: ±0.25		TOLERANCES: X: ±0.35 X.X: ±0.25		TOLERANCES: X: ±0.35 X.X: ±0.25		TOLERANCES: X: ±0.35 X.X: ±0.25	
CAV. No: 1-1		CAV. No: 1-2		CAV. No: 1-16		CAV. No: 1-16	
MOLD No: NA		MOLD No: NA		MOLD No: NA		MOLD No: NA	
SUPPLIER: NA		SUPPLIER: NA		SUPPLIER: NA		SUPPLIER: NA	
TITLE: USB C FLAG TYPE CH 7.63mm		TITLE: USB C FLAG TYPE CH 7.63mm		TITLE: USB C FLAG TYPE CH 7.63mm		TITLE: USB C FLAG TYPE CH 7.63mm	
DRAWN: Chen Lin		DRAWN: Chen Lin		DRAWN: Chen Lin		DRAWN: Chen Lin	
CHKD: Chen Lin		CHKD: Chen Lin		CHKD: Chen Lin		CHKD: Chen Lin	
APP: Wu Gang		APP: Wu Gang		APP: Wu Gang		APP: Wu Gang	
DATE: 2016/06/07		DATE: 2016/06/07		DATE: 2016/06/07		DATE: 2016/06/07	
SCALE: 1:1		SCALE: 1:1		SCALE: 1:1		SCALE: 1:1	
SHEET: 1 OF 1		SHEET: 1 OF 1		SHEET: 1 OF 1		SHEET: 1 OF 1	

深圳市顺宏康科技有限公司
SHK-31022