

| REV. | ECH NO | LOCATIONS | DESCRIPTION | DATE |
|------|--------|-----------|-------------|------|
| | | | | |

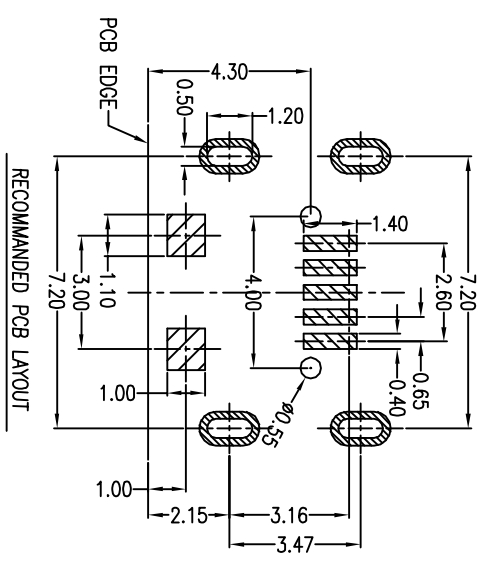
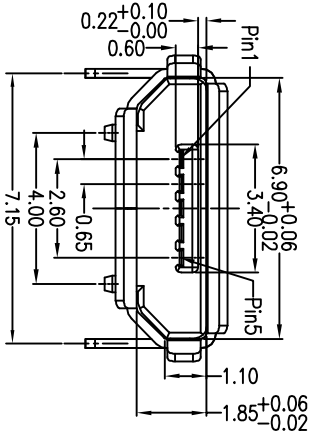
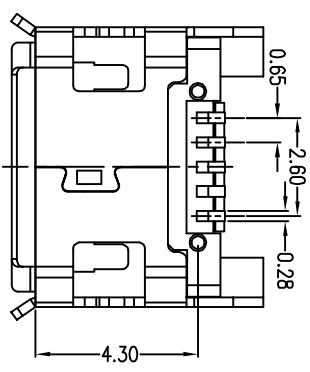
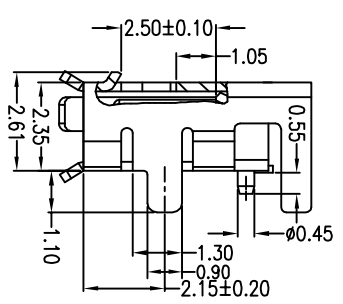
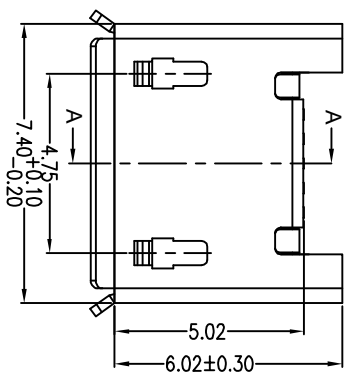
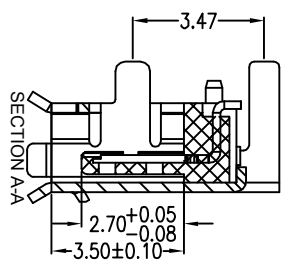
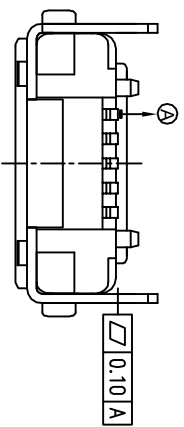

- Note:
- Material:
 - Housing: High temperature thermoplastic with g.f, UL94V-0
 - Contact: copper alloy, t=0.20mm
 - Shell: copper alloy, t=0.25mm
 - Specification:
 - Current rating: 1 A Max.
 - Dielectric withstanding voltage: 100 V(ac) for 1 min.
 - Contact resistance: 50 mW Max.
 - Insulation resistance: 100 MW Min.
 - Total mating force: 3.57 Kgf Max.
 - Total unmating force: 1.0 Kgf Min. 0.81~2.05 Kgf Min.
 - Temperature range: -30°C~80°C

A 01 S B 1 4 1 B 1-276

- 产品代号 A: 部品
- 产品系列 01: micro usb 5pin
- 产品类别 S: 母座
- 产品类型 B: B TYPE
- 外壳材质 1: 2980R-H
- 端子材质 4: 5181R-BH
- 主体材质 1: 10P
- 主体颜色 B: 黑色
- 下板类型 1: dlp (微板)
- 细节流水 2: 8 micro usb 5P/B Type SMT DIP/2端插板/1四脚全插

| | | | |
|----------------------------|----------|--------------------|------------------|
| PART NO: A01SB141B1-276 | | MATERIAL: SEE NOTE | |
| MODEL NO: XX | | FINISH: SEE NOTE | |
| UNIT: MM | SIZE: A4 | COLOR: SEE NOTE | DR: xiyoulong |
| TOLERANCE UNSPECIFIED | | CHK: | |
| .x | 0.15 | APP: | |
| .xx | 0.10 | SCALE: 5:1 | DATE: 2012.05.21 |
| .xxx | 0.05 | REV: A | |
| Ang. | 1° | | |

深圳市顺宏康科技有限公司

TITLE: Micro usb 5P/B Type SMT DIP/2 有引脚长1.1四脚全插

DWG NO: SHK-20043

SCALE: 5:1 DATE: 2012.05.21